

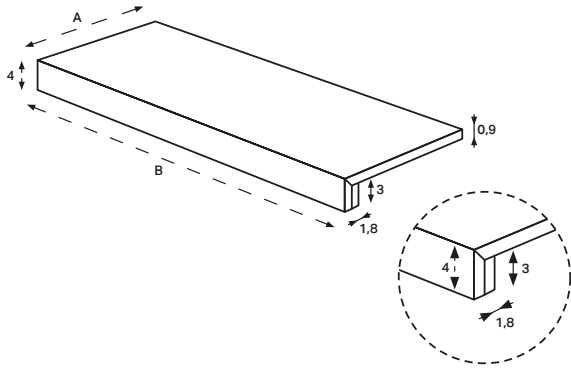

Gradino

A × B
33×150/13"×60"
33×120/13"×48"
33×80/13"×32"
30×60/12"×24"



Gradino Angolare Dx/Sx

A × B
33×150/13"×60"
33×120/13"×48"
33×80/13"×32"
30×60/12"×24"

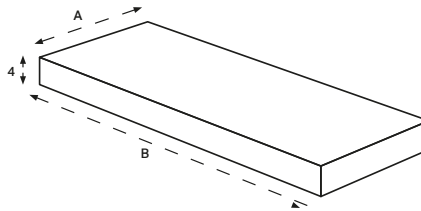

Gradino Angolare

A × B
33×33/13"×13"
30×30/12"×12"

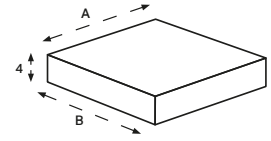

Scalino Elemento L

A × B
33×150/13"×60"
33×120/13"×48"
30×80/12"×32"
30×60/12"×24"

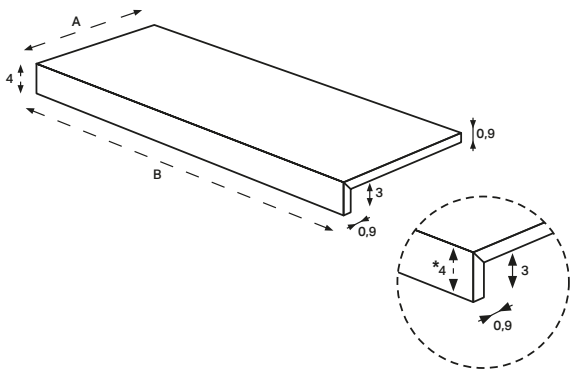

Scalino Elemento L Angolare Dx/Sx

A × B
33×150/13"×60"
33×120/13"×48"
33×80/13"×32"
30×60/12"×24"

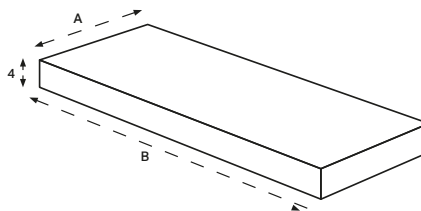

Scalino Elemento L Angolare

A × B
33×33/13"×13"
30×30/12"×12"

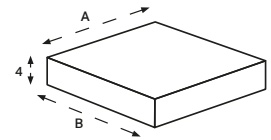

* h 3 for sizes 30x60/12"x24" and 30x30/12"x12"

Gradino industriale

A × B
33×150/13"×60"
33×120/13"×48"
30×80/12"×32"
30×60/12"×24"

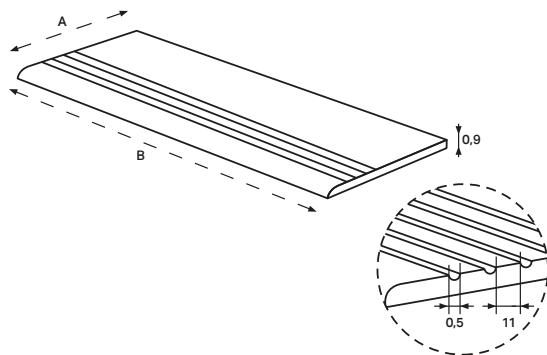

± 20 mm
Trim Tiles



Bordo In/Ex OUT2.0

30x120/12"x48"

30x90/12"x36"

30x60/12"x24"

15x60/6"x24"

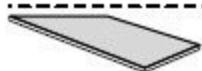

Bordo Angolare Dx/Sx In/Ex OUT2.0

30x120/12"x48"

30x90/12"x36"

30x60/12"x24"

15x60/6"x24"



Bordo Angolare OUT2.0

30x30/12"x12"

15x15/6"x6"

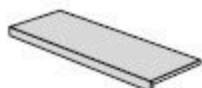

Gradino OUT2.0

30x120/12"x48"

30x90/12"x36"

30x60/12"x24"

15x60/6"x24"



Gradino Angolare Dx/Sx In/Ex OUT2.0

30x120/12"x48"

30x90/12"x36"

30x60/12"x24"

15x60/6"x24"



Gradino Angolare OUT2.0

30x30/12"x12"

15x15/6"x6"

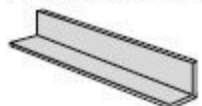

Elemento L OUT2.0

15x120/6"x48"

15x90/6"x36"

15x60/6"x24"

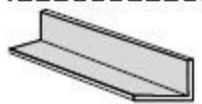

Elemento L Angolare Dx/Sx In/Ex OUT2.0

15x120/6"x48"

15x90/6"x36"

15x60/6"x24"

± 20 mm
Trim Tiles

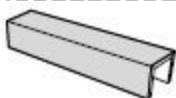

Elemento U OUT2.0

15x120/6"x48"

15x90/6"x36"

15x60/6"x24"

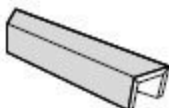

Elemento U Angolare Dx/Sx OUT2.0

15x120/6"x48"

15x90/6"x36"

15x60/6"x24"



Canalina OUT2.0

20x120/8"x48"

15x120/6"x48"

20x90/8"x36"

15x90/6"x36"

20x60/8"x24"

15x60/6"x24"



Canalina Angolare Dx/Sx OUT2.0

20x120/8"x48"

15x120/6"x48"

20x90/8"x36"

15x90/6"x36"

20x60/8"x24"

15x60/6"x24"



Griglia OUT2.0

20x90/8"x36"

15x90/6"x36"

20x60/8"x24"

15x60/6"x24"



Griglia Angolare OUT2.0

20x20/8"x8"

15x15/6"x6"

Beat Echo of Nature

Echo of nature

9 mm

120x120/48"x48" R Matt-Pro
 120x120/48"x48" R C2 GRIP
 60x120/24"x48" R Matt-Pro
 60x120/24"x48" R C2 GRIP
 60x120/24"x48" R Ribbed
 60x60/24"x24" R Matt-Pro
 60x60/24"x24" R C2 GRIP
 30x60/12"x24" R Matt-Pro
 30x60/12"x24" R C2 GRIP

9 mm

180x240/72"x96" R Matt-Pro Kit Linear
 · 2pcs size 80x120cm/32"x48"
 · 2pcs size 60x120cm/24"x48"
 · 2pcs size 40x120cm/16"x48"

 119x119/47"x47" Matt-Pro Kit Carved
 · 1pc size 80x80cm/32"x32"
 · 2pcs size 40x80cm/16"x32"
 · 1pc size 40x40cm/16"x16"

20 mm OUT2.0

60x120/24"x48" R



Concept 2

Highlights 14

Multiformato: Kit Carved	14
Multiformato: Kit Linear	18
3D Wall Coverings: Ribbed	22

Gallery 24

Features 36

The complete range	40
--------------------	----





La variabilità ancestrale della natura si trasforma in una superficie dalla forte personalità nella quale convivono diverse tipologie di pietre. Abbiamo interpretato un materiale millenario con uno sguardo nuovo e contemporaneo, per trasportare negli ambienti la maestosità dell'universo minerale.

The ancient variability of nature transforms into a surface with a strong personality where different types of stones coexist. We've reinterpreted a millennia-old material with a fresh, contemporary perspective to bring the grandeur of the mineral universe into spaces.

Ispirazione naturale e carattere moderno
Natural inspiration and modern character

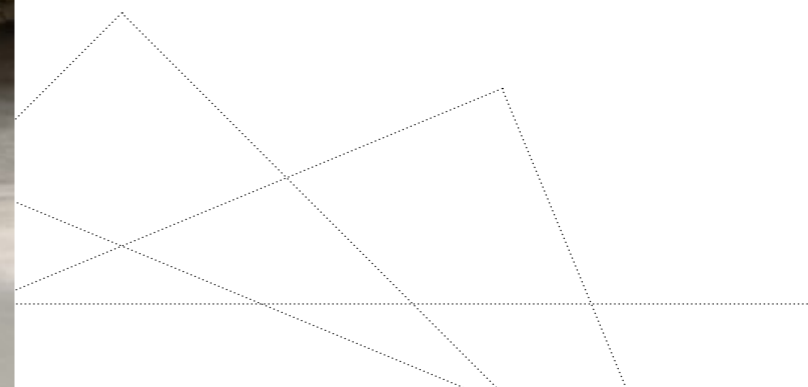

La variabilité ancienne de la nature se transforme en une surface à la personnalité marquée où coexistent différents types de pierres. Nous avons réinterprété un matériau millénaire avec un regard frais et contemporain pour apporter la grandeur de l'univers minéral dans les espaces.

Die urtümliche Variabilität der Natur verwandelt sich in eine Oberfläche mit einer starken Persönlichkeit, auf der verschiedene Arten von Steinen koexistieren. Wir haben ein jahrtausendealtes Material mit einem frischen, zeitgenössischen Blick neu interpretiert, um die Größe des mineralischen Universums in Räume zu bringen.

De eeuwenoude variabiliteit van de natuur transformeert tot een oppervlak met een sterke persoonlijkheid waar verschillende soorten stenen naast elkaar bestaan. We hebben een millennia-oud materiaal opnieuw geïnterpreteerd met een frisse, eigentijdse blik om de grootsheid van het minerale universum naar ruimtes te brengen.

La variabilidad ancestral de la naturaleza se transforma en una superficie con una fuerte personalidad donde coexisten diferentes tipos de piedras. Hemos reinterpretado un material milenario con una mirada fresca y contemporánea para llevar la grandeza del universo mineral a los espacios.







Tracce naturali e segni grafici arricchiscono il fondo su cui si alternano aree chiare e più scure, creando una composizione che si mostra nel complesso equilibrata grazie ai passaggi cromatici sfumati. Con cinque colori dal mood naturale che declinano toni caldi e freddi (White, Almond, Beige, Grey, Mud), quattro formati che garantiscono la massima versatilità (120×120, 60×120, 60×60, 30×60) e due finiture entrambe antiscivolo (Matt-Pro opaca, C2 Grip con struttura applicata) che rispondono a diverse esigenze prestazionali, Beat è una collezione completa che si abbina a molteplici stili e può essere scelta per tutti i tipi di progetti.

Natural traces and graphic signs enrich the background, alternating between light and dark areas, creating a composition that overall displays balance through nuanced chromatic transitions. With five colors inspired by nature offering warm and cool tones (white, almond, beige, grey, mud), four sizes ensuring maximum versatility (120×120, 60×120, 60×60, 30×60), and two finishes both anti-slip (Matt-Pro, C2 Grip with applied texture) catering to different performance needs, Beat is a comprehensive collection adaptable to various styles and suitable for all types of projects.

Estetica equilibrata in una gamma completa
Balanced aesthetics in a complete range

Beige 120×120/48"×48" R Matt-Pro

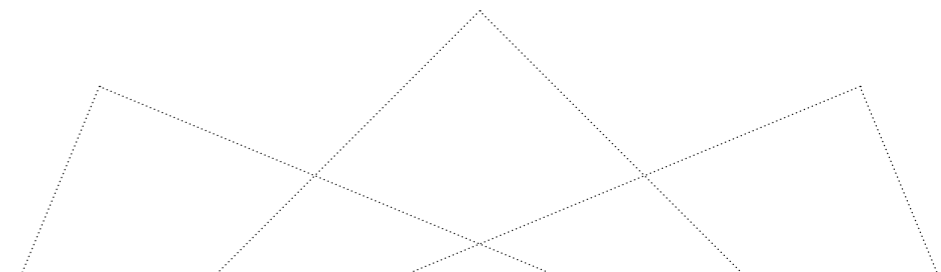

Des traces naturelles et des signes graphiques enrichissent le fond, alternant entre zones claires et sombres, créant une composition globalement équilibrée grâce à des transitions chromatiques nuancées. Avec cinq couleurs inspirées de la nature offrant des tons chauds et froids (blanc, amande, beige, gris, boue), quatre tailles assurant une polyvalence maximale (120×120, 60×120, 60×60, 30×60), et deux finitions toutes deux antidérapantes (Matt-Pro, C2 Grip avec texture appliquée) répondant à différents besoins de performance, Beat est une collection complète adaptable à différents styles et adaptée à tous types de projets.

Natürliche Spuren und grafische Zeichen bereichern den Hintergrund und wechseln zwischen hellen und dunkleren Bereichen, was eine insgesamt ausgewogene Komposition durch nuancierte chromatische Übergänge zeigt. Mit fünf Farben, die warme und kühle Töne bieten (Weiß, Mandel, Beige, Grau, Schlamm), vier Größen, die maximale Vielseitigkeit gewährleisten (120×120, 60×120, 60×60, 30×60), und zwei Oberflächenbehandlungen, die beide rutschfest sind (matt-pro, C2 Grip mit aufgebracht Struktur) und verschiedenen Leistungsanforderungen gerecht werden, ist Beat eine umfassende Kollektion, die sich verschiedenen Stilen anpasst und für alle Arten von Projekten geeignet ist.

Natuurlijke sporen en grafische tekens verrijken de achtergrond, afwisselend tussen lichte en donkere gebieden, wat een over het algemeen gebalanceerde compositie toont door genuanceerde chromatische overgangen. Met vijf kleuren geïnspireerd door de natuur met warme en koele tinten (wit, amandel, beige, grijs, modder), vier maten die maximale veelzijdigheid garanderen (120×120, 60×120, 60×60, 30×60), en twee afwerkingen beide anti-slip (mat-pro mat, C2 Grip met aangebrachte structuur) die voldoen aan verschillende prestatiebehoeften, is Beat een uitgebreide collectie die aanpasbaar is aan verschillende stijlen en geschikt is voor allerlei soorten projecten.

Rastros naturales y signos gráficos enriquecen el fondo, alternando entre áreas claras y oscuras, creando una composición que en conjunto muestra equilibrio a través de transiciones cromáticas matizadas. Con cinco colores inspirados en la naturaleza que ofrecen tonos cálidos y fríos (blanco, almendra, beige, gris, barro), cuatro tamaños que garantizan máxima versatilidad (120×120, 60×120, 60×60, 30×60) y dos acabados antideslizantes (Matt-Pro, C2 Grip con textura aplicada) que atienden a diferentes necesidades de rendimiento, Beat es una colección completa adaptable a varios estilos y adecuada para todo tipo de proyectos.



Almond 120×120/48"×48" R Matt-Pro



1

Sassolini di diverse dimensioni e forme donano carattere e tridimensionalità.

Pebbles of various sizes and shapes give character and three-dimensionality.

Des petits cailloux de différentes tailles et formes apportent du caractère et de la tridimensionnalité.

Kieselsteine verschiedener Größen und Formen verleihen Charakter und Dreidimensionalität.

Kieselsteinen von verschiedenen Formaten in vormalen geben karakter en driedimensionaliteit.

Piedrecitas de diferentes tamaños y formas aportan carácter y tridimensionalidad.

2

Passaggi di colori graduali creano una superficie equilibrata e armoniosa.

Subtle color transitions create a balanced and harmonious surface.

Des transitions de couleurs subtiles créent une surface équilibrée et harmonieuse.

Subtile Farbübergänge schaffen eine ausgewogene und harmonische Oberfläche.

Subtiele kleurovergangen creëren een gebalanceerd en harmonieus oppervlak.

Transiciones de colores sutiles crean una superficie equilibrada y armoniosa.

3

Crepe profonde e graffi leggeri regalano un estremo realismo.

Deep crevices and light scratches provide extreme realism.

Des fissures profondes et des égratignures légères offrent un réalisme extrême.

Tiefe Spalten und leichte Kratzer sorgen für extreme Realitätstreue.

Diepe scheuren en lichte krassen zorgen voor extreme realisme.

Fisuras profundas y rasguños ligeros proporcionan un realismo extremo.

4

Chiaroscuri delicati aggiungono profondità e movimento.

Gentle chiaroscuro adds depth and movement.

Des clairs-obscur délicats ajoutent de la profondeur et du mouvement.

Sanfte Hell-Dunkel-Kontraste fügen Tiefe und Bewegung hinzu.

Zachte licht-donker contrasten voegen diepte en beweging toe.

Chiaroscuros delicados añaden profundidad y movimiento.

4



Il kit multiformato è composto da tre elementi di dimensioni diverse (80×80 + 40×80 + 40×40) che combinati insieme offrono numerose soluzioni di posa. Il bordo è connotato da una particolare lavorazione che rende ogni pezzo unico e diverso dall'altro. Questa tipologia di profilo "scolpito" è una novità per Refin e rappresenta un plus significativo che unisce estetica e funzionalità, perché risulta meno soggetto alla sbeccatura garantendo la massima facilità di posa.

The multiformat kit consists of three elements of different sizes (80×80 + 40×80 + 40×40) that, when combined, offer numerous laying solutions. The edge features a special treatment making each piece unique and distinct from the others. This "carved" profile is a novelty for Refin and represents a significant advantage merging aesthetics and functionality, as it is less prone to chipping, ensuring ease of installation.

Il kit multiformato Carved The multiformat Carved kit

Le kit multiformat se compose de trois éléments de tailles différentes (80×80+40×80+40×40) qui, une fois combinés, offrent de nombreuses solutions de pose. Le bord présente un traitement spécial rendant chaque pièce unique et distincte des autres. Ce profil "sculpté" est une nouveauté pour Refin et représente un avantage significatif combinant esthétique et fonctionnalité, car il est moins sujet aux éclats, garantissant une facilité d'installation.

Das Multiformat-Kit besteht aus drei Elementen unterschiedlicher Größe (80×80+40×80+40×40), die kombiniert zahlreiche Verlegelösungen bieten. Der Rand ist durch eine spezielle Behandlung gekennzeichnet, die jedes Stück einzigartig und von den anderen unterscheidet. Dieses "geschnitzte" Profil ist eine Neuheit für Refin und repräsentiert einen signifikanten Vorteil, der Ästhetik und Funktionalität vereint, da es weniger anfällig für Absplinterungen ist und eine einfache Installation gewährleistet.

Het multiformaat kit bestaat uit drie elementen van verschillende grootte (80×80+40×80+40×40) die, wanneer gecombineerd, tal van legoplossingen bieden. De rand is voorzien van een speciale behandeling waardoor elk stuk uniek is en verschilt van de andere. Dit "gebeitelde" profiel is een nieuwigheid voor Refin en vertegenwoordigt een significante voorsprong waarbij esthetiek en functionaliteit worden gecombineerd, omdat het minder gevoelig is voor afsplintering en een eenvoudige installatie garandeert.

El kit multiformato consta de tres elementos de diferentes tamaños (80×80+40×80+40×40) que, combinados, ofrecen numerosas soluciones de colocación. El borde presenta un tratamiento especial que hace que cada pieza sea única y distinta de las demás. Este perfil "esculpido" es una novedad para Refin y representa una ventaja significativa que combina estética y funcionalidad, ya que es menos propenso a astillarse, garantizando facilidad de instalación.



- Effetto frastagliato e irregolare del bordo
- Processo industriale che simula una martellatura casuale unendo tecnologia e artigianalità
- Maggiore resistenza alla sbeccatura e facilità di posa
- Jagged and irregular edge effect
- Industrial process simulating random hammering combining technology and craftsmanship
- Increased resistance to chipping and ease of installation
- Effet de bord dentelé et irrégulier
- Processus industriel simulant un martelage aléatoire combinant technologie et artisanat
- Résistance accrue à l'écaillage et facilité d'installation
- Zerklüfteter und unregelmäßiger Kanteneffekt
- Industrieller Prozess, der zufälliges Hämmern simuliert und Technologie mit Handwerkskunst verbindet
- Erhöhte Beständigkeit gegen Absplittern und einfache Installation
- Gekarteld en onregelmatig randeffect
- Industrieel proces dat willekeurig hameren simuleert en technologie en vakmanschap combineert
- Verhoogde weerstand tegen afsplinteren en eenvoudige installatie
- Efecto dentado e irregular en el borde
- Proceso industrial que simula un martilleo aleatorio combinando tecnología y artesanía
- Mayor resistencia al astillado y facilidad de instalación

Il kit è disponibile in tutti i colori della collezione; la fuga, che appare più larga rispetto al bordo rettificato, può essere scelta tono su tono per creare uno stile sobrio e tradizionale o a contrasto per ottenere un abbinamento più moderno.

Available in all collection colors, the grout, appearing wider compared to the rectified edge, can be chosen tone-on-tone for a sober, traditional style or in contrast for a more modern pairing.

Schemi di posa/Laying sketches/
Schémas de pose/Modulverlegungsbeispiele/
Legschema/Esquemas de colocación

Kit Carved 119×119/47"×47"

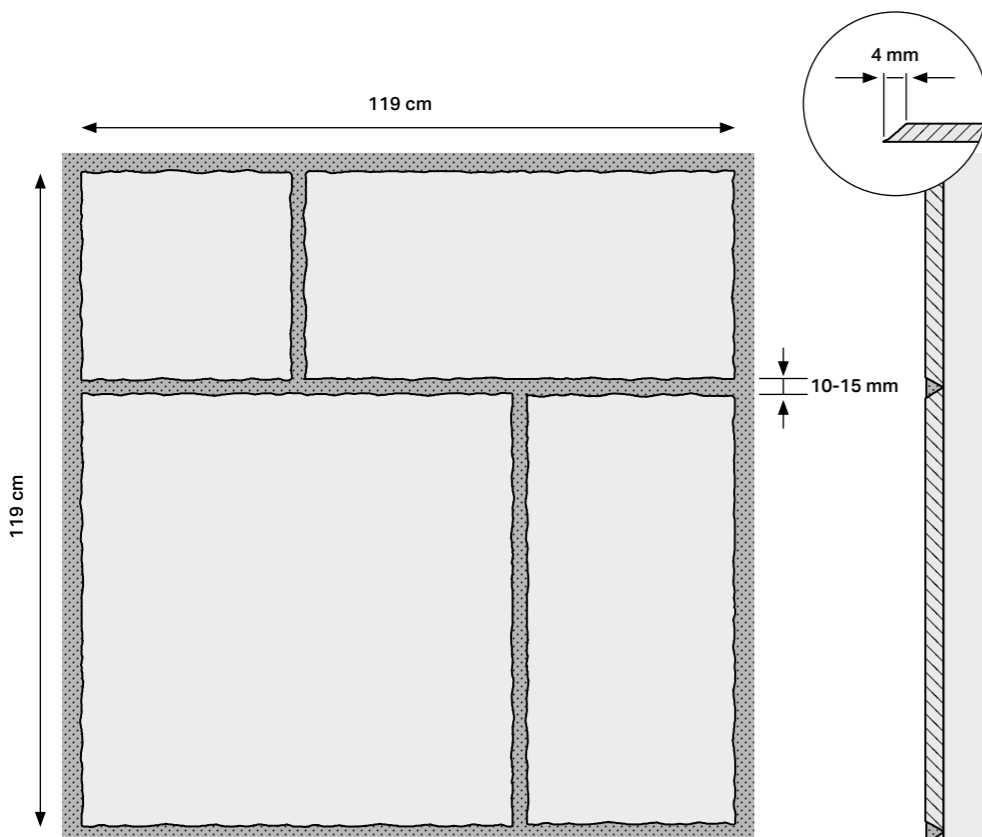
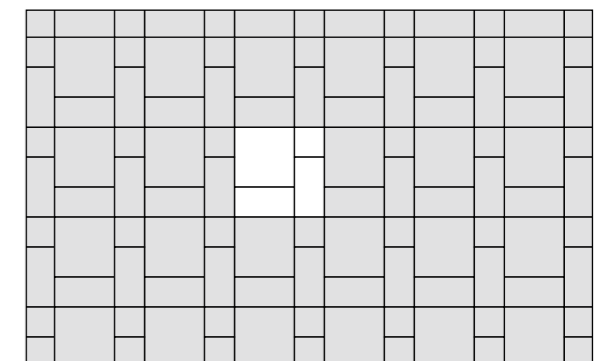
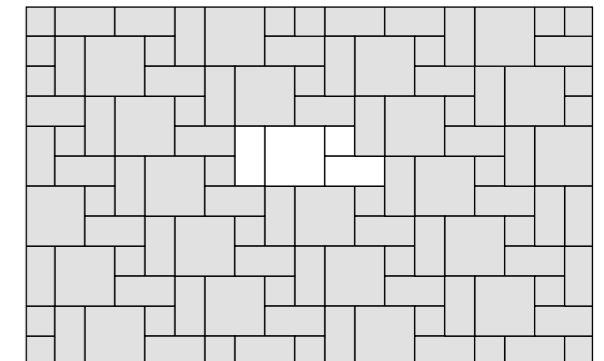

Per mantenere la modularità del kit Carved in caso di posa allineata, si consiglia di utilizzare una fuga alla base di circa 3 millimetri.

Il prodotto posato si presenterà con una fuga visibile variabile da 10 a 15 mm.

To maintain the modularity of the Carved kit in the case of aligned laying, it is recommended to use a joint of 3 millimeters.

Pour maintenir la modularité du kit Carved en cas de pose alignée, il est recommandé d'utiliser un joint de 3 millimètres.

Um die Modularität des Carved-Kits bei einer ausgerichteten Verlegung zu gewährleisten, wird empfohlen, eine Fuge von 3 Millimetern zu verwenden.

Om de modulariteit van het Carved-kit bij een uitgelijnde plaatsing te behouden, wordt aanbevolen om een voeg van 3 millimeter te gebruiken.

Para mantener la modularidad del kit Carved en caso de instalación alineada, se recomienda utilizar una junta de 3 milímetros.

Disponibile dans toutes les couleurs de la collection, le joint, apparaissant plus large par rapport au bord rectifié, peut être choisi ton sur ton pour un style sobre et traditionnel ou en contraste pour une association plus moderne.

Erhältlich in allen Farben der Kollektion kann der Fugenmörtel, der im Vergleich zum geraden Rand breiter erscheint, ton-in-ton für einen zurückhaltenden, traditionellen Stil oder kontrastierend für eine modernere Kombination gewählt werden.

Beschikbaar in alle kleuren van de collectie, kan het voegmiddel, dat breder lijkt in vergelijking met de rechte rand, worden gekozen in dezelfde kleur voor een ingetogen, traditionele stijl of in contrast voor een modernere combinatie.

Disponible en todos los colores de la colección, la junta, que parece más ancha en comparación con el borde rectificado, puede elegirse a tono para un estilo sobrio y tradicional o en contraste para una combinación más moderna.



Kit Linear

Il kit multiformato è proposto anche con bordo rettificato, in tutte le cinque tonalità di Beat. In questa versione i tre elementi, mixabili a piacere sia a pavimento che a rivestimento, hanno dimensioni più ampie (80×120 + 60×120 + 40×120) che ispirano composizioni di gusto contemporaneo.

The multiformat kit is also offered with rectified edges, in all five shades of Beat. In this version, the three elements, mixable both on the floor and on the wall, have larger dimensions (80×120 + 60×120 + 40×120) that inspire compositions of contemporary taste.

Il kit multiformato Linear The multiformat Linear kit

Le kit multiformat est également proposé avec des bords rectifiés, dans les cinq teintes de Beat. Dans cette version, les trois éléments, mixables à volonté aussi bien au sol qu'en revêtement mural, ont des dimensions plus grandes (80×120+60×120+40×120) qui inspirent des compositions au goût contemporain.

Das Multiformat-Kit wird auch mit rektifizierten Kanten in allen fünf Farbtönen von Beat angeboten. In dieser Version haben die drei Elemente, die sowohl auf dem Boden als auch an der Wand gemischt werden können, größere Abmessungen (80×120+60×120+40×120), die zeitgenössische Kompositionen inspirieren.

Het multiformaat kit wordt ook aangeboden met rechtgeslepen randen, in alle vijf tinten van Beat. In deze versie hebben de drie elementen, naar eigen wens te mixen zowel op de vloer als op de muur, grotere afmetingen (80×120+60×120+40×120) die composities inspireren met een eigentijdse smaak.

El kit multiformato también se ofrece con bordes rectificados, en los cinco tonos de Beat. En esta versión, los tres elementos, mezclables tanto en el suelo como en el revestimiento, tienen dimensiones más grandes (80×120+60×120+40×120) que inspiran composiciones de gusto contemporáneo.

Beige Kit Linear 180x240/72"x96" R Matt-Pro



Schemi di posa/Laying sketches/
Schémas de pose/Modulverlegungsbeispiele/
Legschema/Esquemas de colocaciòn

Kit Linear 180x240/72"x96"

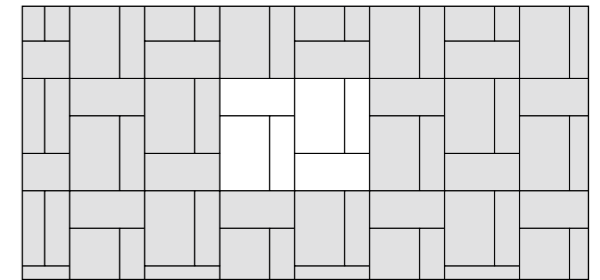
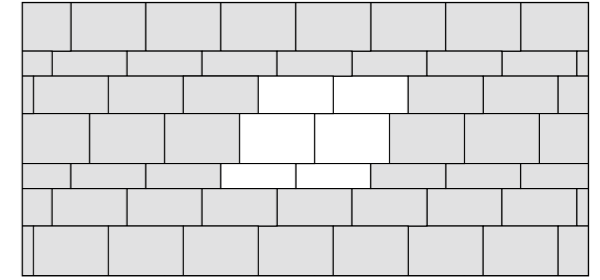



Con il suo effetto di rimando tessile, Ribbed si caratterizza per la marcata tridimensionalità resa possibile dalla tecnica 3Deep, che sovrappone alla superficie una grafica studiata appositamente per ricreare l'ombreggiatura dello spessore. Refin ha messo a punto questo processo innovativo – che combina perfettamente grafica, superficie e struttura – per massimizzare la resa visiva del materiale con ogni incidenza di luce: 3Deep esalta profondità e volume, che risultano così percepibili da tutte le angolazioni sia orizzontalmente che verticalmente.

With its textile reflection effect, Ribbed is characterized by pronounced three-dimensionality made possible by the 3Deep technique, overlaying a specially designed graphic to recreate shading and depth. Refin has developed this innovative process – perfectly combining graphics, surface, and structure – to maximize the visual impact of the material in every light condition: 3Deep enhances depth and volume, perceptible from all angles horizontally and vertically.

La tridimensionalità di Ribbed The three-dimensionality of Ribbed

Avec son effet de réflexion textile, Ribbed se caractérise par une tridimensionalité prononcée rendue possible par la technique 3Deep, superposant une graphique spécialement conçue pour recréer des ombres et de la profondeur. Refin a développé ce processus innovant — combinant parfaitement graphisme, surface, et structure — pour maximiser l'impact visuel du matériau dans toutes les conditions de lumière : 3Deep accentue la profondeur et le volume, perceptible sous tous les angles horizontalement et verticalement.

Mit seinem textilen Reflexionseffekt zeichnet sich Ribbed durch eine ausgeprägte Dreidimensionalität aus, ermöglicht durch die 3Deep-Technik, die eine speziell gestaltete Grafik zur Nachbildung von Schattierungen und Tiefe überlagert. Refin hat diesen innovativen Prozess entwickelt — der Grafik, Oberfläche und Struktur perfekt kombiniert — um die visuelle Wirkung des Materials unter allen Lichtbedingungen zu maximieren: 3Deep betont Tiefe und Volumen, wahrnehmbar aus allen horizontalen und vertikalen Blickwinkeln.

Met zijn textielreflectie-effect wordt Ribbed gekenmerkt door een uitgesproken driedimensionaliteit mogelijk gemaakt door de 3Deep-techniek, die een speciaal ontworpen grafiek over de oppervlakte legt om schaduwen en diepte te recreëren. Refin heeft dit innovatieve proces ontwikkeld — perfect combinatie van grafiek, oppervlakte, en structuur — om de visuele impact van het materiaal te maximaliseren in alle lichtomstandigheden: 3Deep accentueert diepte en volume, waarneembaar vanuit alle hoeken horizontaal en verticaal.

Con su efecto de reflexión textil, Ribbed se caracteriza por una marcada tridimensionalidad gracias a la técnica 3Deep, que superpone una gráfica especialmente diseñada para recrear sombras y profundidad. Refin ha desarrollado este proceso innovador — combinando perfectamente gráficos, superficie y estructura — para maximizar el impacto visual del material en todas las condiciones de luz: 3Deep resalta la profundidad y el volumen, perceptibles desde todos los ángulos horizontal y verticalmente.

Mud 120×120/48"×48" R Matt-Pro — Mud Ribbed 60×120/24"×48" R — White Ribbed 60×120/24"×48" R
White 60×120/24"×48" R Matt-Pro — Cortina Natural 25×150/10"×60" R



White 120×120/48"×48" R Matt-Pro — 60×120/24"×48" R Matt-Pro — Tamashi Pepper 25×150/10"×60" R









Grey Mosaico 30x30/12"x12" R



Grey 120x120/48"x48" R Matt-Pro



V3
Moderate



White
120×120/48"×48" R C2 GRIP
120×120/48"×48" R Matt-Pro
60×120/24"×48" R C2 GRIP
60×120/24"×48" R Matt-Pro
60×60/24"×24" R C2 GRIP
60×60/24"×24" R Matt-Pro
30×60/12"×24" R C2 GRIP
30×60/12"×24" R Matt-Pro

RF04
RE79
RG20
RG14
RG30
RG25
RG40
RG35

Almond
120×120/48"×48" R C2 GRIP
120×120/48"×48" R Matt-Pro
60×120/24"×48" R C2 GRIP
60×120/24"×48" R Matt-Pro
60×120/24"×48" R **OUT2.0**
60×60/24"×24" R C2 GRIP
60×60/24"×24" R Matt-Pro
30×60/12"×24" R C2 GRIP
30×60/12"×24" R Matt-Pro

RE94
RE75
RG16
RG10
RN23
RG26
RG21
RG36
RG31

Beige
120×120/48"×48" R C2 GRIP
120×120/48"×48" R Matt-Pro
60×120/24"×48" R C2 GRIP
60×120/24"×48" R Matt-Pro
60×60/24"×24" R C2 GRIP
60×60/24"×24" R Matt-Pro
30×60/12"×24" R C2 GRIP
30×60/12"×24" R Matt-Pro

RF01
RE76
RG17
RG11
RG27
RG22
RG37
RG32



Grey
120×120/48"×48" R C2 GRIP
120×120/48"×48" R Matt-Pro
60×120/24"×48" R C2 GRIP
60×120/24"×48" R Matt-Pro
60×120/24"×48" R **OUT2.0**
60×60/24"×24" R C2 GRIP
60×60/24"×24" R Matt-Pro
30×60/12"×24" R C2 GRIP
30×60/12"×24" R Matt-Pro

RF02
RE77
RG18
RG12
RN24
RG28
RG23
RG38
RG33

Mud
120×120/48"×48" R C2 GRIP
120×120/48"×48" R Matt-Pro
60×120/24"×48" R C2 GRIP
60×120/24"×48" R Matt-Pro
60×60/24"×24" R C2 GRIP
60×60/24"×24" R Matt-Pro
30×60/12"×24" R C2 GRIP
30×60/12"×24" R Matt-Pro

RF03
RE78
RG19
RG13
RG29
RG24
RG39
RG34

V3
Moderate

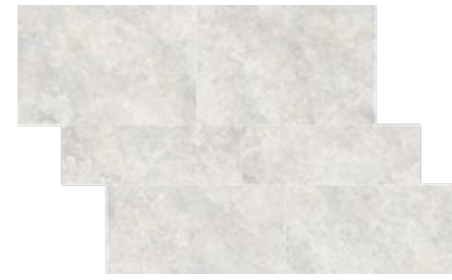
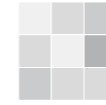

White
Kit Linear 180×240/72"×96" R Matt-Pro



Almond
Kit Linear 180×240/72"×96" R Matt-Pro



Beige
Kit Linear 180×240/72"×96" R Matt-Pro



Grey
Kit Linear 180×240/72"×96" R Matt-Pro



Mud
Kit Linear 180×240/72"×96" R Matt-Pro

Kit Linear 180×240 cm/72"×96" (1 kit = 4,320 m²)

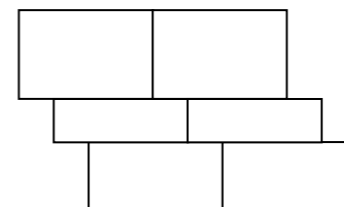

Set per la posa multiformato composto da:/

Multi-format laying set consisting of:
Set de pose multiformat composé de:
Multiformat Verlegeset bestehend aus:
Multiformat legset bestaande uit:
Set de colocación multiformato compuesto por:

- 2pcs size 80×120cm/32"×48"
- 2pcs size 60×120cm/24"×48"
- 2pcs size 40×120cm/16"×48"

Articoli forniti in imballi separati.

Non vendibili singolarmente./
Items provided in separate packaging. Not sold individually./
Articles fournis dans des emballages séparés. Non vendus à l'unité./
Artikel werden in separaten Verpackungen geliefert. Nicht einzeln erhältlich. /
Items worden geleverd in afzonderlijke verpakkingen. Niet los verkrijgbaar./
Artículos suministrados en embalajes separados. No se venden individualmente.

Per codici e imballi, chiedere al proprio referente commerciale. /

For codes and packaging, please consult your sales representative. /
Pour les codes et l'emballage, veuillez consulter votre représentant commercial. /
Für Codes und Verpackung, wenden Sie sich bitte an Ihren Vertriebsmitarbeiter. /
Voor codes en verpakking, raadpleeg uw verkoopvertegenwoordiger. /
Para códigos y embalaje, consulta a tu representante de ventas.



V3
Moderate



White Kit Carved 119×119/47"×47" Matt-Pro RF28



Almond Kit Carved 119×119/47"×47" Matt-Pro RF24



Beige Kit Carved 119×119/47"×47" Matt-Pro RF25



Grey Kit Carved 119×119/47"×47" Matt-Pro RF26



Mud Kit Carved 119×119/47"×47" Matt-Pro RF27

V3
Moderate



White Ribbed 60×120/24"×48" R Strutt. RF87

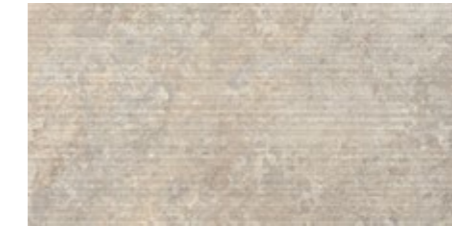

Almond Ribbed 60×120/24"×48" R Strutt. RF84



Beige Ribbed 60×120/24"×48" R Strutt. RF85



Grey Ribbed 60×120/24"×48" R Strutt. RE95

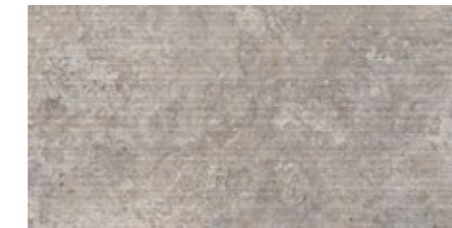

Mud Ribbed 60×120/24"×48" R Strutt. RF86

Mosaici/Mosaics/Mosaiques/
Mosaiken/Mozaïeken/Mosaicos



White Mosaico 30×30/12×12" R RE88



Almond Mosaico 30×30/12×12" R RE84

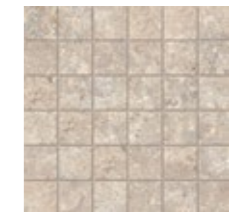

Beige Mosaico 30×30/12×12" R RE85

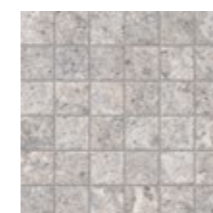

Grey Mosaico 30×30/12×12" R RE86

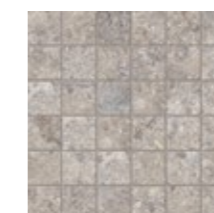

Mud Mosaico 30×30/12×12" R RE87

Kit Carved 119×119 cm/47"×47" (1 kit = 1,416 m²)

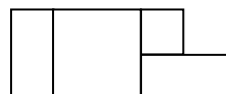

Set per la posa multiformato composto da:
Multi-format laying set consisting of:
Set de pose multiformat composé de:
Multiformat Verlegeset bestehend aus:
Multiformat legset bestaande uit:
Set de colocación multiformato compuesto por:

- 1pc size 80×80cm/32"×32"
- 2pcs size 40×80cm/16"×32"
- 1pc size 40×40cm/16"×16"

Articoli forniti in un unico imballo. Non vendibili singolarmente.
Items provided in a single package. Not sold individually.
Articles fournis dans un seul emballage. Non vendus à l'unité.
Artikel werden in einer einzigen Verpackung geliefert. Nicht einzeln verkaufbar.
Items worden geleverd in één enkele verpakking. Niet los verkrijgbaar.
Artículos suministrados en un solo embalaje. No se venden por separado.

The complete range

Colori/Colours/
Couleurs/Farben/
Kleuren/Colores



V3
Moderate

Formati
Sizes
Formats
Formate
Formaten
Formatos

Tiles
± 9 mm

120×120/48"×48" R
C2 GRIP / Matt-Pro

60×120/24"×48" R
C2 GRIP / Matt-Pro

60×60/24"×24" R
C2 GRIP / Matt-Pro

30×60/12"×24" R
C2 GRIP / Matt-Pro

White



Almond



Beige



Grey



Mud



Kit Linear 180×240/72"×96" R
Matt-Pro



Kit Carved 119×119/47"×47"
Matt-Pro



± 20 mm
OUT 2.0

60×120/24"×48" R

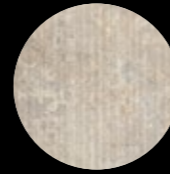

3D Wall Coverings
± 9 mm

Ribbed 60×120/24"×48" R

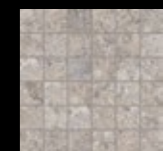
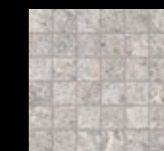
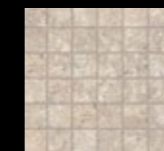
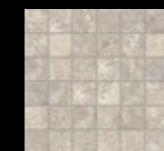
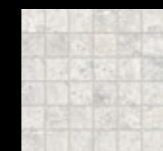

Mosaics
± 9 mm

Mosaico 30×30/12"×12" R



Pezzi speciali/Trim tiles/Pieces speciales/Formteile/Speciale delen/Piezas especiales



Battiscopa	7×60/2^{7/8}×24" R
Almond	RE89
Beige	RE90
Grey	RE91
Mud	RE92
White	RE93

Imballi/Packing/Emballage/Verpackungseinheiten/Verpakking/Embalajes

	pcs × box	m ² / m × box	kg × box	box × pallet	m ² × pallet	kg × pallet
120×120/48"×48"	2	2,8800	59,00	20	57,60	1180,00
60×120/24"×48"	2	1,4400	29,50	35	50,40	1032,50
60×120/24"×48" OUT2.0	1	0,7200	32,50	35	25,20	1137,50
60×60/24"×24"	3	1,0800	21,36	40	43,20	854,40
30×60/12"×24"	7	1,2600	24,50	40	50,40	980,00
Kit Linear 180x240/72"×96"	1	4,3200				
Kit Carved 119×119/47"×47"	1	1,4161	29,20	34	48,15	992,80
30×30/12"×12" Mosaico	11	0,9900	19,00	18	17,82	342,00
7×60/2 ^{7/8} ×24" Battiscopa	10	6,0000	9,00	70	420,00	630,00

Stonalizzazione/Color shading/Denuancement/Farbabweichung/
Kleurnuanceringen/Destonificación

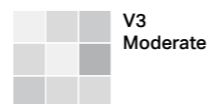

Il prodotto è volutamente caratterizzato da una moderata variazione cromatica e di venature, per ricreare la variabilità e la ricchezza dei materiali naturali ai quali la collezione è ispirata. Per le stesse ragioni si consiglia di posare il materiale scegliendolo da più scatole contemporaneamente per garantire la variabilità e casualità della superficie finita. Date le caratteristiche intrinseche del prodotto, i riferimenti cromatici qui presentati sono dunque da ritenersi puramente indicativi.

The moderate chromatic variation and the veining of the product is an intrinsic feature to re-create the randomness and richness of the colour shading of natural stones to which the collection is inspired. For these reasons, we recommend installing the product choosing tiles from different boxes in order to guarantee a variable and natural random effect of the finished surface. Due to these intrinsic features of the product, the colours represented in this catalogue must only be considered an example of the many possible colour shades.

Le produit est volontairement caractérisé par une variation modérée de la couleur et des veines, pour recréer la variabilité et la richesse des matériaux naturels dont la collection est inspirée. C'est pourquoi il est conseillé de poser le matériau en le choisissant simultanément parmi plusieurs boîtes, afin de garantir la variabilité et l'originalité de la surface finie. En raison des caractéristiques intrinsèques de ce produit, les références chromatiques présentées ici doivent donc être considérées à titre purement indicatif.

Das Produkt wurde gewollt durch eine dezente Variation der Farben und Maserungen geprägt, um die Mannigfaltigkeit und Pracht der natürlichen Materialien wiederzugeben, an denen die Kollektion inspiriert ist. Aus diesem Grund wird auch empfohlen, beim Verlegen Material aus verschiedenen Schachteln zu verwenden, um die Unterschiedlichkeit und Zufälligkeit der fertigen Fläche zu garantieren. Aufgrund der für das Produkt typischen Eigenschaften sind die hier angeführten farblichen Bezugsdaten nur als ungefähre Richtwerte anzusehen.

De gematigde kleurvariaties en nerftekening zijn gewenste intrinsieke karakteristieken van het product. Zij weerspiegelen de variabiliteit en kracht van natuurlijke materialen, de inspiratiebron van deze collectie. Om deze reden raden wij aan de tegels bij plaatsing uit verschillende dozen te kiezen, ter garantie van een ultiem random en natuurlijk effect voor het eindopervlak. Gezien de intrinsieke eigenschappen van het product zijn de hier getoonde kleurreferenties zuiver benaderend.

El producto se caracteriza adrede por una moderada variación de color y de vetas para recrear la variabilidad y riqueza de los materiales naturales en los que se ha inspirado la colección. Por ello, se aconseja colocar el material eligiéndolo simultáneamente de más de una caja para garantizar la variabilidad y casualidad de la superficie acabada. Dadas las características intrínsecas del producto, las referencias cromáticas que se presentan son puramente indicativas.

Caratteristiche/Features/Caracteristiques/Eigenschaften/Eigenschappen/Características

C2 GRIP, OUT2.0

UNI EN ISO 10545-14	DIN EN 16165:2023 Annex B (previously DIN 51130)	DIN EN 16165:2023 Annex A (previously DIN 51097)	BS EN 16165:2021 Annex C (previously BS 7976-2:2002)	B.C.R.A. Rep. CEC/81	ANSI A326.3 (BOT 3000) Test Method
Classe 5 / Class 5	R11	A+B+C	PTV ₈₈ ≥ 36 Wet	Conforme / Compliant	wet DCOF ≥ 0.55

MATT-PRO

UNI EN ISO 10545-14	DIN EN 16165:2023 Annex B (previously DIN 51130)	DIN EN 16165:2023 Annex A (previously DIN 51097)	BS EN 16165:2021 Annex C (previously BS 7976-2:2002)	B.C.R.A. Rep. CEC/81	ANSI A326.3 (BOT 3000) Test Method
Classe 5 / Class 5	R10	A+B	PTV ₈₈ ≥ 36 Wet	Conforme / Compliant	wet DCOF ≥ 0.50

Almond 120×120/48"×48" R Matt-Pro



Qualità certificata	Certified quality	Qualité certifiée	Zertifizierte qualität	Gecertificeerde Kwaliteit	Calidad certificada
Ceramiche Refin SpA è certificata secondo ISO 9001. Tutto il processo produttivo è sottoposto a controlli severi per una garanzia di alta qualità.	Ceramiche Refin SpA is ISO 9001 certified. The entire production process is subject to strict controls for guaranteed high-quality materials.	Ceramiche Refin SpA est certifiée selon ISO 9001. Tout le procédé de production est soumis à des contrôles rigoureux afin de garantir un matériau haut de gamme.	Ceramiche Refin SpA ist nach ISO 9001 zertifiziert. Das gesamte Produktionsverfahren unterliegt strengsten Kontrollen, um höchste Qualitätsstandards gewährleisten zu können.	Ceramiche Refin SpA is gecertificeerd volgens ISO 9001, het gehele productieproces wordt aan strenge controles onderworpen ter garantie van een hoge kwaliteit.	Ceramiche Refin SpA está certificada mediante la norma ISO 9001.Todo el proceso productivo está expuesto a severos controles para una garantía de alta calidad.
Ceramiche Refin si riserva il diritto di apportare in qualsiasi momento modifiche o variazioni ai prodotti presenti in questo catalogo.	Ceramiche Refin reserves the right to change the products presented in this catalogue at any time.	Ceramiche Refin se réserve à tout moment la faculté d'apporter des modifications ou des variations sur les produits présentés sur ce catalogue.	Die Firma Ceramiche Refin behält sich das Recht vor, jederzeit Änderungen an den in Katalog aufgeführten Produkten vorzunehmen.	Ceramiche Refin behoudt zich het recht voor om op elk moment wijzigingen of variaties aan de producten in deze catalogus door te voeren.	Ceramiche Refin se reserva el derecho de aportar en cualquier momento modificaciones o variaciones a los productos presentes en este catálogo.
La proprietà intellettuale del presente catalogo è riservata per tutti i Paesi. La traduzione, la riproduzione, la memorizzazione elettronica e l'adattamento totale o parziale e con qualsiasi mezzo (compresi microfilm e copie fotostatiche) dei suoi contenuti comporta la violazione dei diritti di copyright di REFIN SpA I prodotti raffigurati nelle immagini del presente catalogo sono protetti secondo la normativa vigente in materia di proprietà industriale.	All the intellectual property rights of this catalogue are reserved in all countries. Translation, reproduction in print or electronic form, and adaptation, in whole or in part, using any means (including microfilm and photocopy formats) of the contents of the said catalogue constitute a violation of REFIN SpA's copyright. The products featured in the photographs in this catalogue are protected by current industrial property legislation.	La propriété intellectuelle de ce catalogue est réservée, pour tous les pays. Toute traduction, reproduction, mémorisation par voie électronique et adaptation, intégrale ou partielle, par quelque procédure que ce soit (y compris les microfilms et les photocopies), de son contenu, est illicite et constitue la violation des droits de copyright de REFIN SpA. Les produits représentés sur les images de ce catalogue sont protégés, conformément à la réglementation en vigueur en matière de propriété industrielle.	Das geistige Eigentum ist für alle Länder geschützt. Die Übersetzung, Vervielfältigung, elektronische Speicherung und vollständige oder teilweise Verarbeitung seiner Inhalte mit jeglichem Mittel (einschließlich Mikrofilm und Fotokopie) bewirkt die Verletzung der Urheberrechte von REFIN SpA. Die im vorliegenden Katalog abgebildeten Produkte sind gemäß den geltenden einschlägigen Bestimmungen zum gewerblichen Eigentumsrecht geschützt.	De intellectueleeigendom van deze catalogus is voor alle landen voorbehouden. De vertaling, de reproductie, de elektronische opslag en de totale of gedeeltelijke aanpassing met welk middel dan ook (inclusief microfilm en fotokopieën) van de inhoud van deze catalogus brengt de schending van de copyright van REFIN SpA, met zich mee. De producten getoond in de afbeeldingen van deze catalogus zijn beschermd volgens de geldende wetgeving inzake industriële eigendom.	La propiedad intelectual de este catálogo está reservada para todos los países. La traducción, reproducción, almacenamiento electrónico y la adaptación total o parcial por cualquier medio (microfilms y copias comprimidas) de los contenidos, significa la violación de los derechos de autor de Ceramiche Refin SpA. Los productos reflejados en las imágenes del presente catálogo están protegidos de acuerdo a la norma vigente en materia de propiedad industrial.
Le informazioni contenute nel presente catalogo sono il più possibile esatte, ma non sono da ritenersi legalmente vincolanti. Per esigenze di produzione ci riserviamo il diritto di apportare eventuali modifiche che si rendono necessarie. Peso, colori e misure sono soggetti alle inevitabili variazioni tipiche del processo di cottura della ceramica. I colori indicati si avvicinano quanto più possibile a quelli reali nei limiti consentiti dai processi di stampa. I consigli e le istruzioni date pur essendo oggetto di studi e prove eseguite con la massima serietà, sono da ritenersi puramente indicative. Le caratteristiche tecniche riportate su questo catalogo annullano e sostituiscono quelle preesistenti nel precedente catalogo generale e nei cataloghi di serie.	The information contained in this catalogue is correct to the best of our knowledge, but is not to be construed as legally binding. We reserve the right to make changes and when production requirement under them necessary. Weight, colours and Size are subject to the usual variation expected in fired ceramic products. Colours shown are as close to the real colour as the limitation of the printing process will allow. While being the result of carefully effected studies and tests, these suggestions and instructions should be considered purely indicative. The technical characteristics given in this catalogue cancel and replace all previous characteristics in the general catalogue and in the range catalogues.	Les renseignements contenus dans ce catalogue sont le plus possible exacts, mais ils ne sont sous la tutelle d'aucune jurisprudence. A cause d'exigences de production, nous nous réservons le droit d'apporter d'éventuelles modifications qui seront nécessaires. Les poids, couleurs et mesures sont sujets à d'inévitables variations typiques au processus de cuisson de la céramique. Les couleurs indiquées sont fidèles dans les limites consenties par les procédés d'imprimerie. Les conseils et les données, tout en étant le résultat d'études et d'essais très soignés, doivent être considérés comme purement indicatifs. Les caractéristiques techniques indiquées dans ce catalogue annulent et remplacent les caractéristiques qui étaient présentes dans le précédent catalogue général et dans les catalogues de série.	Die im vorliegenden Katalog enthaltenen Angaben sind so genau wie möglich gehalten, sind aber rechtlich unverbindlich. Falls produktionstechnisch erforderlich, behalten wir uns vor eventuelle Minderungen vorzunehmen. Gewicht, Farbe und Ausmasse der Fliesen unterliegen der unumgärliglichen. Toleranzen eines keramischen Ofenbrandes. Die abgebildeten Farben entsprechen Innerhalb der drucktechnischen Grenzen der Wirklichkeit. Die vorstehenden Anleitungen sind zwar das Ergebnis von Studien und Tests, die mit einem Höchstmaß in Seriosität durchgeführt wurden, aber dennoch nur als Orientierungswerte zu verstehen. Die in diesem Katalog angegebenen, technischen Merkmale, annullieren und ersetzen die im früheren Hauptkatalog bzw. Katalogen der einzelnen Serien gemachten Angaben.	De informatie in deze catalogus is zo exact mogelijk, maar moet niet als wettelijk bindend worden beschouwd, voor productieredenen behouden wij ons het recht voor eventueel de nodige wijzigingen aan te brengen. Gewicht, kleuren en maten zijn aan onvermijdelijke wijzigingen onderhevig die typisch zijn voor het bakproces van de keramiek. De aangegeven kleuren komen zo dicht mogelijk bij de echte kleuren, binnen de limieten die zijn toegestaan bij de drukprocedure. Het advies en de instructies die zijn gegeven moeten, ook al zijn ze onderwerp van studies en tests die met maximale ernst zijn uitgevoerd, enkel als indicatief worden beschouwd. De technische eigenschappen die in deze catalogus zijn aangegeven annuleren en vervangen de eerder bestaande eigenschappen in de vorige algemene catalogus en in de standaardcatalogi.	La información contenida en el presente catálogo son lo más exactas posibles pero no pretenden ser legalmente vinculantes. Por exigencia de producción se reserva el derecho de aportar eventuales modificaciones que resulten necesarias. Peso, color y dimensión están sujetos a las inevitables variaciones típicas del proceso de cocción de la cerámica. Los colores indicados se acercan lo máximo posible a aquellos reales dentro de los límites del proceso de impresión. Los consejos e instrucciones dadas, a pesar de ser objetos de estudio y pruebas realizadas con la máxima seriedad, se consideran puramente indicativos. Las características técnicas detalladas en este catálogo anulan o sustituyen las ya existentes en catálogos precedentes tanto generales como de serie.

Legenda/Legend/Légende/Legende/Legende/Leyenda Gres Fine Porcellanato – EN 14411 ISO 13006 Gruppo Bla Annex G

	Regulation	Required standards	Refin Value
	UNI EN ISO 10545/2	<p>Dimensioni/Sizes/Dimensions/ Abmessungen/Afmetingen/ Dimensiones</p> <p>Lunghezza e larghezza/Length and width/Longueur et largeur/Länge und Breite/Lengte en breedte/ Longitud y anchura</p> <p>Spessore/Thickness/Epaisseur/ Stärke/Dikte/Grosor</p> <p>Rettilineità spigoli/Linearity/ Rectitude des arêtes/ Kantengeradheit/Rechtheid kanten/ Rectitud de los lados</p> <p>• Ortogonalità/Wedging/ Orthogonalité/Rechtwinkligkeit/ Haaksheid hoeken/Ortogonalidad</p> <p>Planarità/Warpage/Planéité/ Ebenfächigkeit/ Vlakheid/Planitud</p>	<p>Non rettificato Not rectified</p> <p>± 0,6 % max 2 mm</p> <p>± 0,3 % max 1mm</p> <p>Conforme Compliant</p> <p>± 5 % max 0,5 mm</p> <p>± 5 % max 0,5mm</p> <p>Conforme Compliant</p> <p>± 0,5 % max 1,5mm</p> <p>± 0,3 % max 0,8mm</p> <p>Conforme Compliant</p> <p>± 0,5 % max 2mm</p> <p>± 0,3 % max 1,5mm</p> <p>Conforme Compliant</p> <p>± 0,5 % max 2mm</p> <p>± 0,4 % max 1,8mm</p> <p>Conforme Compliant</p>
* According to ISO 13006.			
	UNI EN ISO 10545/3	Assorbimento acqua / Water absorption / Absorption d'eau / Wasseraufnahme / Waterabsorptie / Absorción de agua	≤ 0,5 % ≤ 0,2%
	UNI EN ISO 10545/4	Resistenza alla flessione / Flexural Strength/Résistance à la flexion / Biegefestigkeit / Buigvastheid / Resistencia a la flexión	≥ 35 N/mm ² S ≥ 1300 N (thickness ≥ 7,5 mm)
	UNI EN ISO 10545/5	Coefficiente di restituzione (COR) / Coefficient of restitution (COR) / Coefficient de restitution (COR) / Schlagfestigkeit (COR) / Restitutiecoëfficiënt (COR) / Coeficiente de restitución (COR)	Valore consigliato ≥ 0,55/ Recommended value ≥ 0,55/ Valeur recommandée ≥ 0,55/ Empfohlener Wert ≥ 0,55/ Aanbevolen waarde ≥ 0,55/ Rvalor recomendado ≥ 0,55
	UNI EN ISO 10545/6	Resistenza all'abrasione profonda / Deep abrasion resistance / Résistance à l'abrasion / Widerstand gegen Tiefenverschleiß / Weerstand tegen afschuren / Resistencia a la abrasión profunda	≤ 175 mm ³ Solo per piastrelle non smaltate / Only for unglazed tiles
	UNI EN ISO 10545/7	Resistenza all'abrasione/ Abrasion resistance/ Résistance à l'abrasion/ Abriebbeständigkeit/ Weerstand tegen afschuring/ Resistencia a la abrasión	PEI Solo per piastrelle smaltate / Only for glazed tiles
	UNI EN ISO 10545/8	Coefficiente di dilatazione termica lineare / Coefficient of thermal linear expansion / Coefficient de dilatation thermique linear / Linearer Wärmeausdehnungskoeffizient / Lineaire thermische uitzetting / Coeficiente de dilatación termica linear	Metodo di prova disponibile / Tests method available / Methode d'essai disponible / Verfügbares / rüfverfahren / Testmethode beschikbaar / Método de prueba disponible
	UNI EN ISO 10545/9	Resistenza agli sbalzi termici / Thermal shock resistance / Résistance aux écarts de température / Temperaturwechselbeständigkeit / Temperatuurswisselingen / Resistencia al choque térmico	Nessun campione deve presentare difetti visibili / No sample must show visible defects / Aucun échantillon ne doit présenter des défauts visibles / Kein Exemplar darf sichtbare Schäden aufweisen / Geen enkel monster mag zichtbare gebreken vertonen / Ninguna muestra debe presentar defectos visibles
	UNI EN ISO 10545/10	Dilatazione all'umidità / Moisture expansion / Dilatation à l'humidité / Feuchtigkeitsausdehnung / Uitzetting door vocht / Dilatación por la humedad	Metodo di prova disponibile / Tests method available / Methode d'essai disponible / Verfügbares / Prüfverfahren / Testmethode beschikbaar / Método de prueba disponible
	UNI EN ISO 13501-1	Resistenza al fuoco / Fire resistance / Résistance au feu / Brandverhalten / Brand weerstand / Resistencia al fuego	Dichiarare un valore / Declare a value Classe A1 oppure A _{1s} / Class A1 or A _{1s}
	UNI EN ISO 10545/12	Resistenza al gelo / Frost resistance / Résistance au gel / Frostbeständigkeit / Vorstandigheid / Resistencia a la helada	Resistenti/Resistant / Resistants / Widerstandsfähig / Weerbarstig / Resistentes

Legenda/Legend/Légende/Legende/Legende/Leyenda Gres Fine Porcellanato – EN 14411 ISO 13006 Gruppo Bla Annex G

	Regulation	Required standards	Refin Value
	UNI EN ISO 10545/13	Resistenza all'attacco chimico / Chemical resistance / Resistance à l'attaque chimique / Beständigkeit gegen Chemikalien / Chemische bestandheid / Resistencia al ataque químico	Resistenza ai prodotti chimici di uso domestico ed agli additivi per piscina / Resistance to household chemicals and swimming pool salts
	UNI EN ISO 10545/13	Resistenza a basse concentrazioni di acidi e alcali / Resistance to low concentrations of acids and alkalis	Classe minima B (GB per piastrelle smaltate) / Minimum class B (GB for glazed tiles) Classe minima B (UB per piastrelle non smaltate) / Minimum class B (UB for unglazed tiles)
	UNI EN ISO 10545/13	Resistenza ad alte concentrazioni di acidi e alcali / Resistance to high concentrations of acids and alkalis	Dichiarare una classe / Declare a class Metodo di prova disponibile / Tests method available
	UNI EN ISO 10545/14	Resistenza alle macchie / Stain resistance / Insensibilité aux taches / Beständigkeit gegen Fleckenbildner / Substanzen / Weerstand tegen viekken / Resistencia a las manchas	UGL Dichiarare un valore / UGL Declare a value GL ≥ 3
	UNI EN ISO 10545/15	Cessione di piombo e cadmio/ Lead and cadmium discharge/ Perte de plomb et cadmium/ Abgabe von Blei und Cadmium/ Ontaan van lood en cadmium/ Cesión de plomo y cadmio	Valore dichiarato / Declared value Al limite di rilevamento / Than instrument limit
	DIN EN 16165:2023 Annex B (previously DIN 51130)	Indicazione di resistenza allo scivolamento / Assessment of slip resistance / Indication de la résistance au glissement / Bestimmung der Trittsicherheit / Indicatie voor de slipvastheid / Indicación de resistencia al deslizamiento	Dichiarare un valore (R) / Declare a value (R) Dichiarare un valore (A+B+C) / Declare a value (A+B+C)
	DIN EN 16165:2023 Annex A (previously DIN 51097)		Dichiarare un valore / Declare a value Vedere interno See inside
	BS EN 16165:2021 Annex C (previously BS 7976-2:2002)		Dichiarare un valore / Declare a value Vedere interno See inside
	B.C.R.A. Rep. CEC/81	Coefficiente di attrito dinamico / Measurement of dynamic coefficient of friction / Mesure du coefficient de frottement dynamique / Messung des dynamischen Reibungskoeffizienten / Meting van de dynamische wrijvingscoëfficiënt / Coeficiente de rozamiento dinámico	Asciutto > 0,40 / Bagnato > 0,40 Dichiarare un valore / Declare a value Vedere interno See inside
	DCOF ANSI A326.3 (BOT 3000) Test Method		Dichiarare un valore / Declare a value Vedere interno See inside

Ceramiche Refin
SpA

Sede legale
Via I Maggio, 22
Salvaterra
42013 Casalgrande RE
Italia

Showroom aziendale
Via G. Ambrosoli, 2
Salvaterra
42013 Casalgrande RE
Italia

t +39 0522 990 499
f_{ITA} +39 0522 849 270
f_{ESP} +39 0522 990 578
e info@refin.it

refin.com
